

LITHIUM IRON PHOSPHATE BATTERY — LP15-12100
ELECTRICAL PERFORMANCE

Nominal Voltage	12.8 V
Nominal Capacity	100 Ah
Capacity @ 20A	300 min
Energy	1280 Wh
Resistance	≤30 mΩ @ 50% SOC
Self Discharge	<3% / Month

CHARGE PERFORMANCE

Recommended Charge Current	20A
Maximum Charge Current	50A
Recommended Charge Voltage	14.6V
BMS Charge Cut-Off Voltage	<15.6 V (3.9V/Cell)
Reconnect Voltage	>14.4 V (3.6V/Cell)
Balancing Voltage	<14.4 V (3.6V/Cell)
Maximum Batteries in Series	4 (*Consult MUST)

MECHANICAL PERFORMANCE

Dimension (L x W x H)	320 x 172 x 215 mm 13.0 x 6.7 x 8.5"
Approx. Weight	27.8 lbs (12 kg)
Terminal Type	DIN POST
Terminal Torque	80 ~ 100 in-lbs (9 ~ 11 N-m)
Case Material	ABS+PC
Enclosure Protection	IP65

DISCHARGE PERFORMANCE

Maximum Continuous Discharge Current	50 A
Peak Discharge Current	80 A (3s)
BMS Discharge Cut-Off Current	120 A ±5 A (30ms)
Recommended Low Voltage Disconnect	11 V (2.75V/Cell)
BMS Discharge Cut-Off Voltage	>8.0 V (2s) (2.0V/Cell)
Reconnect Voltage	>10.0 V (2.5V/Cell)
Short Circuit Protection	250 ~ 500 μs

TEMPERATURE PERFORMANCE

Discharge Temperature	-4 ~ 131 °F (-20 ~ 55 °C)
Charge Temperature	-4 ~ 113 °F (0 ~ 45 °C)
Storage Temperature	23 ~ 95 °F (-5 ~ 35 °C)
BMS High Temperature Cut-Off	149 °F (65 °C)
Reconnect Temperature	131 °F (55 °C)

COMPLIANCE

Certifications	CE (battery) UN38.3 (battery) UL1642 & IEC62133 (cells)
Shipping Classification	UN 3480, CLASS 9

HEATING FOIL PERFORMANCE

Heating Temperature Range	-4 to 41 °F (-20 to 5 °C)
Heating Time	Approximately 1 hour @ 7.5 A
BMS Heating Foil Cut-Off	158 °F (70 °C)

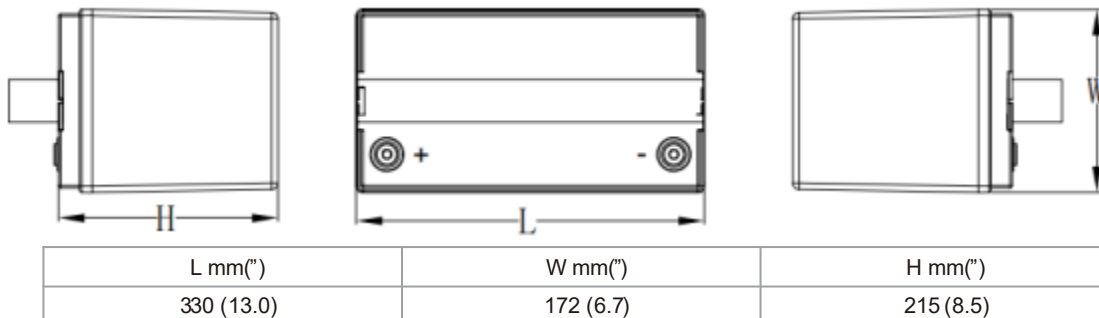
OUTLINE DIMENSION



Performance may vary depending on application. All specifications are subject to change without prior notice to the user. This data is for evaluation purposes only. No guarantee is intended or implied by this data. For clarification and updated information, please contact us.

LITHIUM IRON PHOSPHATE BATTERY — LP15-12100

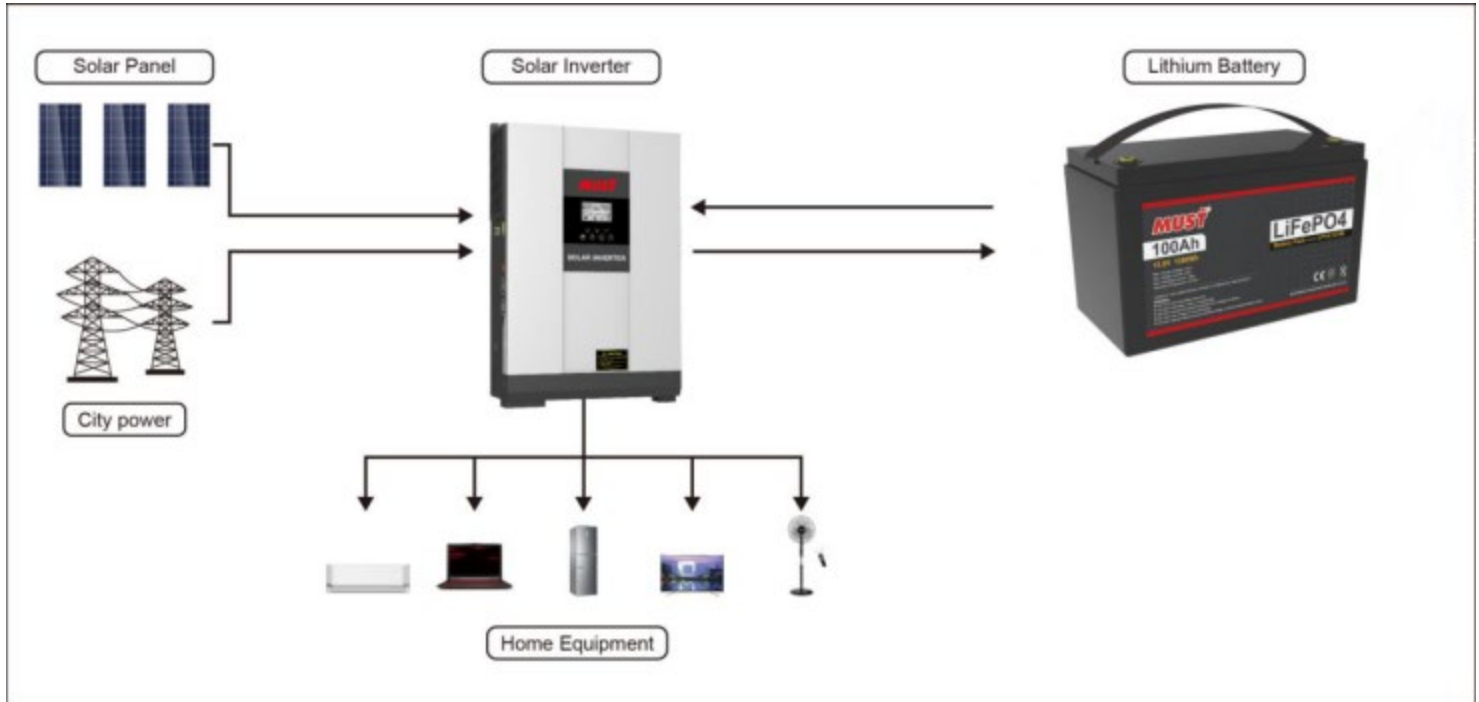
SYSTEM DIAGRAM





FEATURES & BENEFITS

- 
High cycle life
 4000 cycles @80% DoD for effectively lower total of ownership cost.

- 
Longer service life
 Low maintenance batteries with stable chemistry.

- 
Built in circuit protection
 Battery Management System (BMS) is incorporated against abuse.

- 
Better storage
 up to 6 months thanks to its extremely low self discharge (LSD) rate and no risk of sulphation.

- 
Quickly recharge
 Save time and increase productivity with less down time thanks to superior charge/discharge efficiency.

- 
Extreme heat tolerance
 Suitable for use in a wider range of applications where ambient temperature is unusually high: up to +60°C.

- 
Lightweight
 Lithium batteries provide more Wh/Kg while also being up to 1/3 the weight of its SLA equivalent.

APPLICATIONS

Lithium Iron Phosphate can be used in most applications that use Lead Acid, GEL or AGM type batteries. Suitable applications include:

- Caravan
- Marine
- Golf Car
- Buggies
- Solar Storage
- Remote Monitoring
- Switching applications and more
- UPS

CAUTIONS

- Do NOT short circuit, reverse polarity, crush or disassemble.
- Do NOT heat or incinerate.
- Do NOT immerse in any liquid.
- Store at 30~50% SOC. Recharging every 3 months is recommended. The storage area should be clean, cool, dry and ventilated.

Performance may vary depending on application. All specifications are subject to change without prior notice to the user. This data is for evaluation purposes only. No guarantee is intended or implied by this data. For clarification and updated information, please contact us.